

HEWLETT-PACKARD JOURNAL



MAY 1969

Introducing the Computing Counter

Here is the most significant advance in electronic counters in recent years.

By Gary B. Gordon and Gilbert A. Reeser

EVERYTHING ELECTRONIC COUNTERS have done before is done better — a hundred, even a thousand times better in some respects — by a new Hewlett-Packard digital instrument which will also do some useful things no electronic counter could do before. Really a new kind of digital measuring device, the Model 5360A Computing Counter makes extensive computation an integral, indispensable part of its measurement process. Among other things, it will

- measure frequencies from 0.01 Hz to 320 MHz directly.
- measure to 10 significant digits in one second.
- measure time interval with 1 ns accuracy and 100 ps resolution.
- measure pulsed carrier frequencies directly.
- compute a wide variety of things, such as $\Delta f/f$, phase, or averages, under control of its programmable accessory keyboard.
- make sampled frequency and transient measurements.
- accept plug-ins, including frequency converters that measure to 18 GHz, and many new types to be developed in the future.

As a counter, the new instrument is orders of magnitude more powerful than any counter has ever been before. The significance of the ± 1 count uncertainty inherent in electronic

counters is reduced 1000 times in the computing counter by a combination of interpolation and computation. This is why it measures time interval with an accuracy of one nanosecond and with 100 picosecond resolution. It displays answers to as many as 11 significant digits.

To measure frequency, the counter actually measures period, then inverts it to get frequency. The advantages of period counting over direct frequency counting are well known; the rate at which information is resolved is almost always higher. In the computing counter this rate is higher yet because of interpolation.* As a result, the counter measures frequency many times more accurately than conventional counters in the same measuring time, or it gives the same accuracy in a fraction of the time. For example, in measuring frequencies of 90 kHz, 1 MHz, and 320 MHz with the measurement time set at one second, the computing counter gives 10-digit resolution, whereas a conventional counter would give

resolutions of 5, 7, and 9 digits, respectively. To give the same resolution as the computing counter, the conventional counter would need measuring times of about 28 hours, 17 minutes, and 10 seconds, respectively.

Benefits of Computation

Owing to its computational capability, the computing counter is much more automatic than other counters,

* See article, page 9.

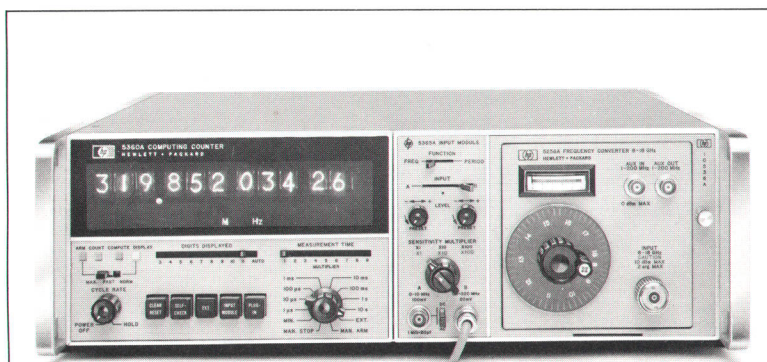

Fig. 1. Model 5360A Computing Counter is orders of magnitude more powerful than earlier counters. It measures CW or pulsed carrier frequencies between 0.01 Hz and 320 MHz to as many as 11 significant digits. Frequency-converter plug-ins extend its range to 18 GHz. It measures period (and time interval with another plug-in) with 1 ns accuracy and 0.1 ns resolution.

and is therefore easy to operate despite its great flexibility. Measuring things like frequency, period, and time interval, the user is completely unaware of the operation of the computing circuits. Yet it is computation that makes the instrument so powerful; the addition, subtraction, multiplication, and division required for period inversion and interpolation are done automatically by the counter's arithmetic unit.

If he wants to, the user can tap the computational power. In conjunction with an accessory keyboard which will be introduced later this year, the new instrument becomes in effect a programmable desk calculator. This one, however, has some keys that aren't found on desk calculators. These keys command the counter to make measurements, and the commands can be mixed with computational steps. This means the counter can be programmed to solve equations whose input variables are real-time measurements. Applications include such things as units conversion and distance or velocity displays derived from time-interval measurements. Phase angles in degrees or radians can be computed from time-interval and period measurements. Many relationships between frequencies can be computed, such as $f_1 \pm f_2$, $f_1 f_2$, $f(t-\Delta t) - f(t)$, f_1/f_2 , and fractional deviation $\Delta f/f_0$. Statistical quantities such as the mean and variance of a sequence of measurements are easily computed, and automated go/no-go testing is facilitated by a comparison output.

It was the small, inexpensive and reliable integrated circuit that made it feasible to get all of the computing counter's circuitry into a cabinet only 5¼ inches high. Putting more capability into the same size box is one of the major instrumentation trends that IC's have brought about; the other major trend, of course, is to make smaller instruments which have capabilities equal to those of their transistorized counterparts. About 500 IC packages are used in the computing counter, many of them specially developed at HP for this instrument. Some of these special IC's are also used in the Model 5323A Automatic Counter, a seven-digit, 0.125-Hz-to-20-MHz, period-inverting frequency counter. This smaller but in some ways similar instrument is described in the article beginning on page 17.

Flexible Organization

The computing counter is really designed as a universal digital instrument, so its organization is highly flexible and decidedly uncounterlike. In the mainframe are a digital processor, a very stable time base, and a display. All operations—measurements, arithme-

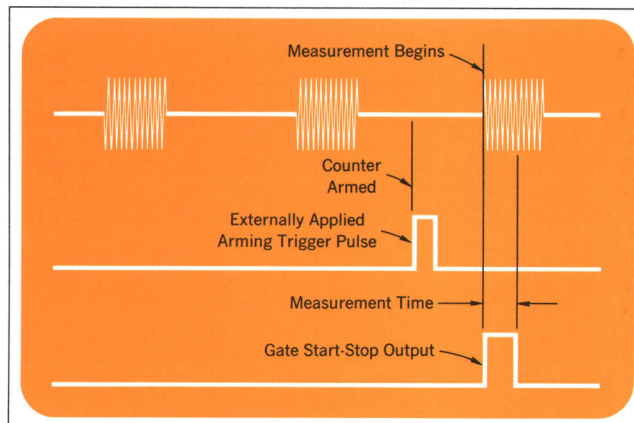

Fig. 2. External triggers or gates can be applied to the computing counter to make it measure the frequency of any part of a burst of a carrier signal. The measurement starts with the next input cycle after the leading edge of the trigger or gate. The counter will also measure the frequency of a single burst without external gates; it arms itself, then starts counting with the first input cycle.

tic operations, and displays—are programmed, and they can be mixed or modified simply by changing programs. One place where this organizational flexibility is bound to be felt is in plug-in design. Plug-ins are limited only by the requirement that they convert their inputs into digital signals or pulses and tell the mainframe what to do to produce a meaningful result. Hence the range of possibilities for future plug-ins is very broad, and the potential of these plug-ins is very high because they can all take advantage of 0.1 ns resolution, 10-digit-per-second speed, and high stability—all properties of the basic instrument. The first new plug-in to be introduced,

Cover: Evident in these displays are a few of Model 5360A Computing Counter's extraordinary capabilities: eleven-digit multiple-period averages, 0.1 ns time-interval resolution, velocity or phase computed from time-interval and distance or frequency measurements, and 11-digit frequency measurements to 320 MHz.

In this Issue: Introducing the Computing Counter; page 2. The Measurement Cycle and the Concept of Arming; page 5. An Electronic Counter for the 1970's; page 9. Computation for Measurement Flexibility; page 13. Automatic Counter Inverts Period to Get Frequency; page 17.

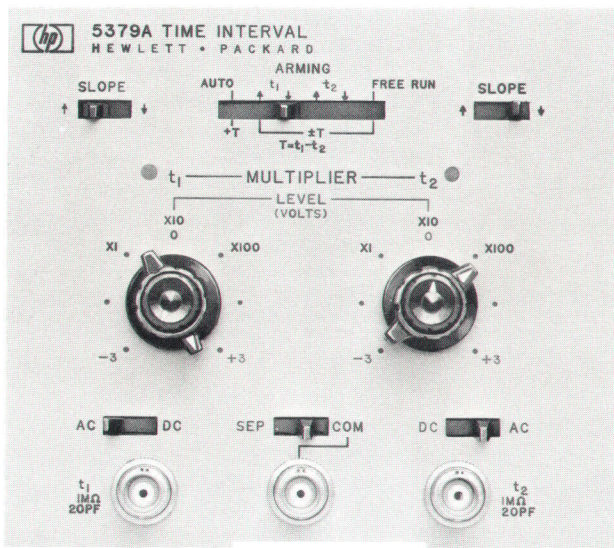

Fig. 3. Model 5379A Time-Interval Plug-in is used with the computing counter to measure time intervals with ± 1 ns accuracy and ± 0.1 ns resolution. Intervals down to zero can be measured, and if the stop pulse (t_2 input) occurs before the start pulse (t_1 input) the display will have a minus sign.

Model 5379A, measures time interval with 100 ps resolution. Standard HP frequency converters* and other plug-ins can also be used in the computing counter; an adapter is available to install them in the computing counter's larger plug-in compartment.

There are actually two plug-in compartments in the mainframe. The smaller plug-in, called the input module, can be changed in about five minutes, using a screwdriver. The first input module to be introduced, Model 5365A, is used in basic parameter measurements such as frequency, period, ratio, and scaling. Future input modules may have wider frequency ranges, greater sensitivity, or other capabilities.

There are no function switches on the mainframe; function switches are all on the input module and the plug-in, so the counter's functions can be changed by changing the module or the plug-in. The counter can measure with the input module or the plug-in or both. Besides added protection from obsolescence, therefore, having two plug-ins gives the counter two signal-entry areas and makes it possible to measure and compute relationships between signals. There can also be larger and more complex plug-ins in the future that will fill the entire space normally taken up by a module and a plug-in.

* The frequency converters were originally designed for the 5245L and related counters. They are Models 5254B, 5255A, and 5256A.

Frequency Measurements

Frequencies are measured with the computing counter very much as they are with ordinary counters. The unknown frequency is first connected to the proper input of the input module. There are two inputs, input A for 0.01 Hz to 10 MHz and input B for 1 kHz to 320 MHz. Next the MODULE pushbutton on the front panel is pressed, the MEASUREMENT TIME, CYCLE RATE, SENSITIVITY, TRIGGER LEVEL and SLOPE, and FUNCTION controls are set to appropriate positions, and the answer appears on the display. Measurements are displayed around a stationary decimal point and the display tubes are grouped in threes to make the display more readable. The numerical display is accompanied by appropriate measurement units (e.g., Hz, Sec, etc.) and a prefix multiplier which is computed by the counter (e.g., k for kilo, M for mega, etc.). There are 12 digital display tubes, to permit shifting the displayed value (11 digits maximum) around the fixed decimal point. Insignificant digits and leading zeros are automatically blanked so only significant digits are displayed, or any number of digits from 3 to 11 can be selected manually. Internally, however, the computer always carries 11 digits.

The computer applies hysteresis to eliminate display jitter at range-change points such as that between 999 kHz and 1.00 MHz. This prevents small changes in the least significant digit from causing both the displayed data to shift and the units to change. In the case of a frequency changing around 1.00 MHz, for example, the reading will change from 999 kHz to 1.00 MHz as the frequency increases, but then if the frequency decreases again, the reading will go to .999 MHz instead of 999 kHz. Hysteresis will keep the range from changing until the frequency is 10% lower than 1.00 MHz.

All these display features make for easy, quick, error-free readings.

The computing counter can make more than 300 frequency measurements per second; hence it can act as a frequency sampler. At this rate its maximum resolution is six digits. It will give 3-digit resolution in a 100 ns measurement, four digits in 1 μ s, six digits in 100 μ s.

Pulsed Signal Frequency Measurements

The computing counter can measure the carrier frequencies of pulsed signals without accessories. Because it isn't confined to a synchronous measurement cycle or to decade values for gate times, it can measure the frequency of a single burst of carrier. The measuring cycle can start automatically when the input signal arrives, just

as an oscilloscope sweep does when it is triggered by the input signal rather than free-running (see Fig. 2 and explanation of 'arming,' page 5), and the measurement time can be anything up to 100 seconds. The counter simultaneously measures its own 'gate time' and counts input cycles, then computes frequency.

External triggers and gates can be applied to the computing counter to make it ignore any uninteresting modulation at the beginning or end of the measured sample, or to make it measure just a portion of a burst of carrier. These features, coupled with high accuracy for short measurement times, make the computing counter a powerful tool for pulsed and sampled frequency measurements.

Period and Time-Interval Measurements

In period and time-interval measurements the computing counter's accuracy exceeds that of a conventional counter which has a 1 GHz clock frequency (none do — 100 MHz is the maximum). Its resolution is equivalent to that of a conventional counter which has a 10 GHz clock

frequency. The display is in tenths of nanoseconds and is accurate within ± 1 ns*. The counter can measure period directly using its input module, making up to 300 measurements per second.

For time-interval measurements, the Model 5379A Time-Interval Plug-in is used (see Fig. 3). Except for its ARMING switch, the plug-in's controls are similar to those of any time-interval counter. If the time-interval measurement is between two points on different waveforms, the two input signals are connected to the t_1 and t_2 inputs and the SEP-COM switch is set to SEP. If the measurement is between two points on the same waveform, the input signal is connected to the middle connector on the plug-in and the switch is set to COM. The counter displays the interval $t_2 - t_1$, and there is no minimum value; time intervals down to zero can be measured in increments of 100 ps, and negative time intervals (t_2 occurs first) are displayed with a minus sign.

The ability to measure zero and negative time inter-

* The specifications are similar to those of a digital voltmeter since, like a DVM, the computing counter derives its last three digits by analog means.

The Measurement Cycle and the Concept of Arming

A typical measuring cycle in the computing counter consists mainly of arming the input, counting, computing the answer, and displaying the results.

Arming is something new to electronic counters. Unless it is armed, the counter will ignore the input signal. Once armed, the counter will begin its measurement process when the input signal triggers the counting circuits. Counting stops with the next input trigger after the arming signal is removed. The advantages of arming are similar to those of using the triggered sweep of an oscilloscope rather than the free-running sweep. For example, it enables the counter to measure the frequency of a single short burst of signal.

There are three operating modes. In the normal mode, whose cycle is shown, arming is internal and automatic. Measurement time is set on the front-panel switches, and measurements occur automatically at a rate determined by the CYCLE RATE controls. This mode is most frequently used for general-purpose measurements.

In the triggered mode the measurement time set on the front panel starts when the input signal triggers the counting circuits, but that can't happen until an external trigger signal is applied to arm the counter.

In the external-measurement-time mode, measurement time is the duration of the externally applied arming signal.

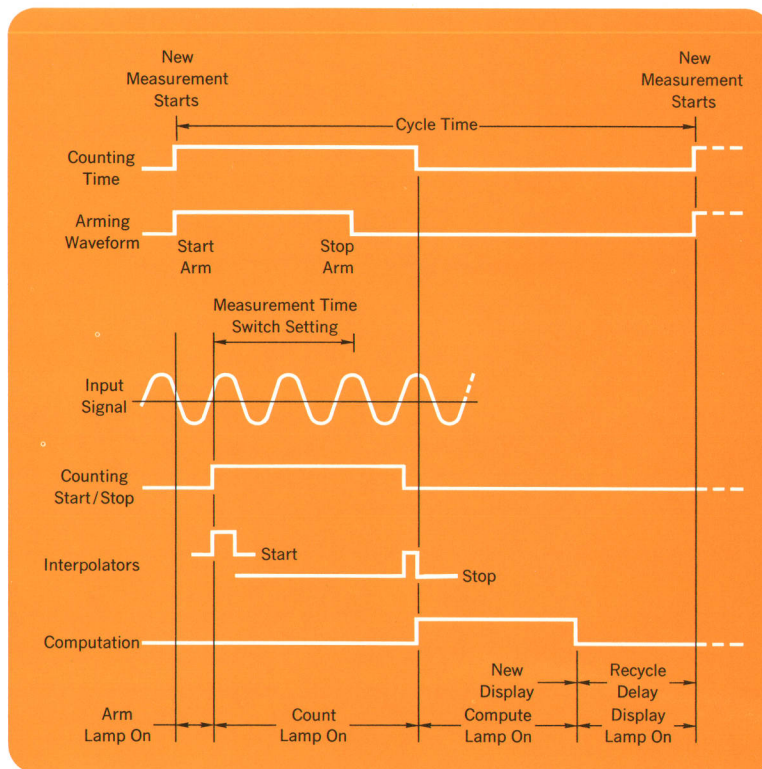

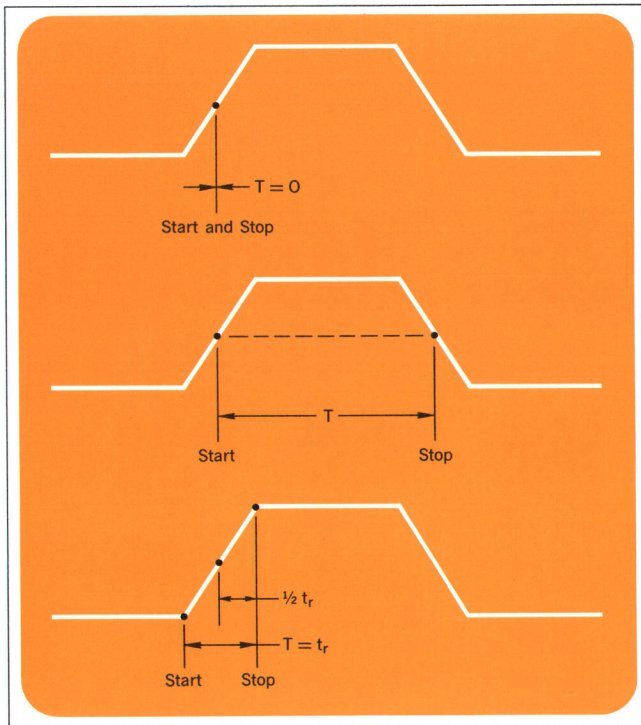

Fig. 4. Because it can measure zero time interval the Model 5379A Time-Interval Plug-in is useful for very-high-resolution pulse-width measurements. The procedure is as follows. 1) Connect the signal to the COM input. 2) Assuming a positive pulse, set both channels to trigger on a positive slope. 3) Adjust both LEVEL controls so both channels are triggering, then continue to adjust them until the measured time interval is zero. This sets up the condition illustrated in the top diagram. 4) Switch the stop channel (t_2) to trigger on a negative slope and read the time interval T (middle diagram). If you want the pulse width at approximately the 50% level, the procedure is as follows. 1) Do the first three steps as before, except for setting up the zero condition. 2) Now move the start level down and the stop level up until triggering just occurs in both channels. This sets up the condition shown in the bottom diagram and measures the rise time of the pulse. 3) Move the start level up until the reading is half the rise time, then move the stop level down until the reading is zero. This sets up the condition in the top diagram, with both trigger points at approximately the 50% level. 4) Switch the stop channel to negative slope and read the pulse width.

vals makes the plug-in useful for measuring pulse rise times or very narrow pulse widths. The procedure is outlined in Fig. 4.

Arming the Time-Interval Plug-in

When the ARMING switch of the time-interval plug-in is in the AUTO position, an input at t_1 must start the measurement and an input at t_2 stops it. With the ARMING switch at FREE RUN the first input trigger, whether it is t_1 or t_2 , starts the measurement, and if t_2 has occurred

first the display will have a minus sign. With the ARMING switch in any of its other positions, the t_1 and t_2 input signals serve as signals for arming the counter as well as for defining the time interval to be measured. For example, with the ARMING switch set to $t_1 \uparrow$, the t_1 signal will arm the counter when it reaches the level set on the t_1 LEVEL control and is positive-going. Then the measurement proceeds as for FREE RUN. If t_2 arrives first the answer is displayed with a negative sign.

Unlike conventional time-interval counters, the plug-in can be armed by an external signal. Thus certain events in a succession of events can be selected to start and stop the measurement.

Frequency-Period Input Module

The Model 5365A Frequency-Period Input Module is similar to the front end of a normal counter. Each of the two input channels consists of an attenuator followed by an amplifier and a trigger circuit which shape the input signal into pulses for counting. The input module also includes a program board, which tells the counter and arithmetic unit what to do when making measurements with the module.

The A output of the module goes directly to the count section in the mainframe. The B output is divided by 32 in the mainframe before going to the count section. The maximum input frequency to the count section is then 10 MHz, regardless of which input channel is used.

Dividing Channel B's output by 32 before applying it to the interpolators means that at least 33 cycles of the B input signal must be received for any frequency or period measurement to be made. However, dividing the B input by 32 to extend the counter's frequency range for the same measurement times doesn't result in a loss of accuracy or resolution, as it would in a conventional counter using a prescaler. This is because the computing counter actually measures period, not frequency, so its ± 1 count uncertainty is related to the time base, not to the input frequency.

Keyboard Taps Computational Power

The computational capability of the computing counter can be made available to the user by means of the Model 10537A Keyboard, an accessory which will be introduced later this year (see Fig. 5). The uses of the keyboard in conjunction with the counter vary widely. In the simplest case it gives the user the equivalent of a desk calculator, with all the usual operations of add, subtract, multiply, divide, square-root, reciprocal, and various in-

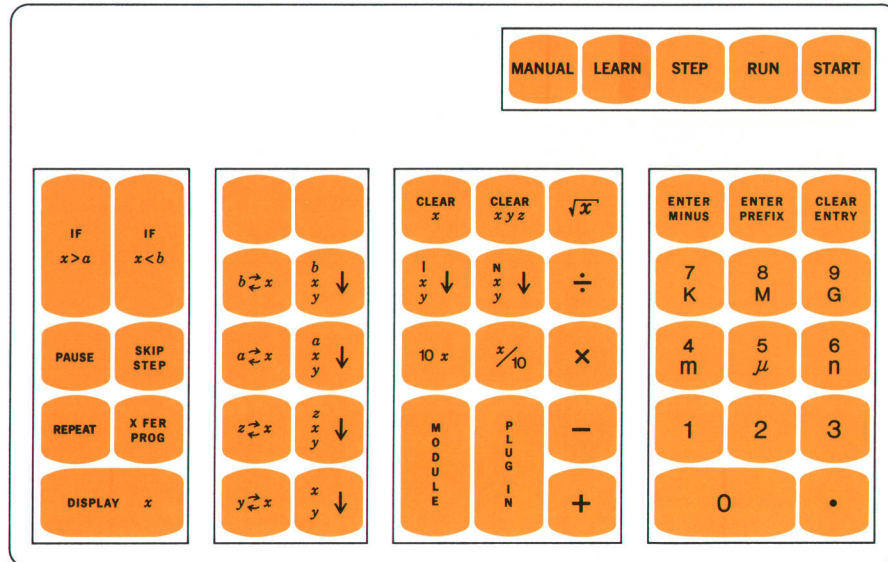

Fig. 5. This is the key configuration of the Model 10537A Keyboard which will be introduced later this year. With the computing counter, it gives the user anything from a desk calculator to a complete programmable measurement system capable of making multiple measurements and interprocessing them digitally before display. Applications include units conversion, computing phase and $\Delta f/f$, rms calculations, and many others.

terchanges of data between registers. Data can be entered in fixed-point, floating-point, or mixed notation. But the real advantage comes from using the keyboard and counter as a complete programmable measurement system, capable of making multiple measurements and interprocessing them digitally before display. Two keys command the counter to take measurements from either the input module or the plug-in. These measurements can then be operated on as part of a program. There is a LEARN key which causes the keyboard to remember a program of as many as 32 steps. Then when the RUN key is pressed the counter will repeat the program over and over, displaying the results after each cycle. Learned programs can be split into two sections and the second section — up to 16 steps — can be performed a number of times at any point in the first section. If an error or an invalid operation — such as division by zero or a register overflow — occurs at any point in a program, an asterisk appears on the display.

Using the Keyboard

The example which follows shows the flexible control that the keyboard has over the measurement and display functions of the counter in systems applications. Another example, one that demonstrates how the computational power can be used to increase resolution and decrease noise, can be found in the article on page 13.

Measurement of a receiver's received-signal frequency is awkward for conventional counters. This signal isn't

strong enough in amplitude to be counted directly, and before much amplification can take place it is heterodyned down to the receiver's intermediate frequency. After several stages of IF amplification it can be counted, but then to determine the signal frequency one must use a second counter to measure the local-oscillator fre-

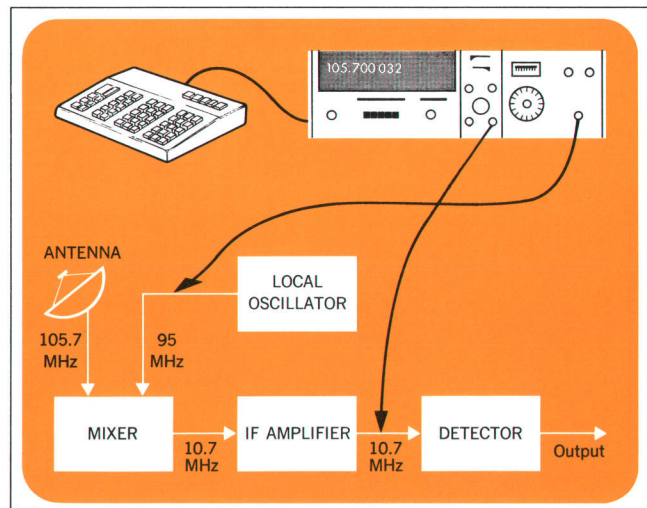

Fig. 6. This is an example of how the keyboard and the computing counter can work together to make measurements that would be awkward for conventional counters. The received signal at 105.7 MHz is too weak to be counted. A simple six-step program directs the counter to measure the 95 MHz LO frequency and the 10.7 MHz IF and add them to get the received frequency.

TENTATIVE SPECIFICATIONS

HP Model 5360A

Computing Counter (with 5365A Input Module)

FREQUENCY/PERIOD MEASUREMENTS

Both frequency and period are measured by measuring the period of one or more cycles of the input waveform. Computing circuits invert the result for direct readout in frequency in the frequency mode.

INPUT CHANNEL B

RANGE: 1 kHz to 320 MHz, ac coupled.
 IMPEDANCE: 50 ohms nominal, low VSWR.
 MAXIMUM SENSITIVITY: 15 mV rms. Stepped SENSITIVITY MULTIPLIER: $\times 1$, $\times 10$, $\times 100$.
 LEVEL CONTROL: Continuously adjustable. PRESET position automatically centers trigger level about 0 V.
 PULSE MEASUREMENT: LEVEL control permits counting pulses of any duty cycle or amplitude from 42 mV to overload level, and of either polarity.
 OVERLOAD PROTECTION: Diodes protect input for up to 3.5 V rms in $\times 1$ SENSITIVITY POSITION, 35 V rms in $\times 10$, and 70 V rms in $\times 100$.

INPUT CHANNEL A

RANGE: 0.01 Hz to 10 MHz, dc coupled, 10 Hz to 10 MHz, ac coupled.
 IMPEDANCE: 1 M Ω shunted by 15 pF.
 SENSITIVITY: 100 mV rms maximum. Stepped SENSITIVITY MULTIPLIER: $\times 1$, $\times 10$, $\times 100$.
 LEVEL CONTROL: Continuously adjustable over range of ± 3 V dc multiplied by SENSITIVITY MULTIPLIER position. PRESET position centers trigger level about 0 V.
 OVERLOAD PROTECTION: Diodes protect input for up to 120 V rms in $\times 1$ SENSITIVITY MULTIPLIER position, 250 V rms in $\times 10$, 500 V rms in $\times 100$.
 CHANNEL SELECTION: Channel A or B can be selected for measurement by a switch on the Model 5365A Input Module.

ACCURACY: $\pm \frac{1 \times 10^9}{\text{Counting Start/Stop time}} \pm \text{trigger error} \pm \text{time base error}$.

MEASUREMENT SPEED

CYCLE TIME: The overall time (Cycle Time) required for a measurement is: Counting Time + Compute Time + Recycle Delay. Its minimum duration is set by the CYCLE RATE controls.

COUNTING TIME: Measurement Time + Interpolating Time.
 MEASUREMENT TIME: This is the time set on front panel MEASUREMENT TIME controls: 1 μ s to 10 s in decade steps, multiplied by integers from 1 to 9 selected by the MULTIPLIER. In the External Mode, measurement time is the duration of the external trigger signal applied to the rear panel EXT. MEASUREMENT TIME connector.
 INTERPOLATING TIME: 300 μ s, max.
 COMPUTE TIME: < 3 ms for frequency and period measurements, < 1 ms for time interval.
 RECYCLE DELAY: The time remaining between completion of all other steps and the end of CYCLE TIME; with CYCLE RATE control at MAX, there is no delay.

Ratio Measurements

DISPLAYS: f₁/f₂ or Period₁/Period₂.

Scaling

CHANNEL A: By decades to 10⁶, 0 to 10 MHz.
 CHANNEL B: By '32 \times decades' to 10⁶, 1 kHz to 320 MHz.

Time Base

CRYSTAL FREQUENCY (internal): 5 MHz.

STABILITY:

AGING RATE: < 5 parts in 10⁶ per 24 hours after warm-up.
 SHORT TERM (rms fractional frequency deviation): Better than 5 parts in 10¹¹ for 1 second averaging time.
 TEMPERATURE: < 5 parts in 10¹¹/°C from 0° to 50°C (< 2.5 parts in 10⁹ within the entire span of 0° to 50°C).
 LINE VOLTAGE: $< \pm 1$ part in 10⁶ for 10% change in line voltage from 115 V or 230 V rms.
 LOAD STABILITY: Typically $< \pm 2$ parts in 10¹¹ for any of the following loads: open, short, 50 Ω resistive, 50 Ω inductive, 50 Ω capacitive.
 WARM-UP: For 'off' periods up to approximately 24 hours: 1 hour typical to reach 5 parts in 10⁹ of the frequency that existed when turned off. The time base is kept warm whenever power cord is connected; output is available with power switch on.
 OUTPUT FREQUENCIES (rear panel BNC): 5 MHz high purity sine wave, 1 V rms into 50 Ω , 10 MHz and 1 MHz rectangular wave, 1 V p-p into 50 Ω . All outputs available when power switch is on.

EXTERNAL FREQUENCY INPUT: External 5 MHz or 10 MHz signal can serve in place of internal time base; 1 V rms into resistive 50 ohm load. Rear panel BNC.

General

BLANKING: In AUTO position of DIGITS DISPLAYED selector, only the number of digits that are within counter accuracy capability (assuming no input signal noise or time base error) are displayed. Otherwise, the DIGITS DISPLAYED selector determines the number of digits displayed. Leading zeros are automatically suppressed.

DIGITAL OUTPUT: Character serial, 4-bit parallel, 4-line BCD, -8421 code with 1111 representing Blank; 15 characters including sign, 12 digits and measurement units; 1 MHz rate; logic levels compatible with TTL integrated circuits.

OPERATING TEMPERATURE: 0 to +50°C.

PRICE: \$6,500.00.

HP Model 5379A Time-Interval Plug-In

ACCURACY: ± 1 nanosecond \pm time base accuracy.

DISPLAYED RESOLUTION LIMIT: 100 picoseconds.

MEASUREMENT RATE: Greater than 1000 per second.

SENSITIVITY: 300 mV peak-to-peak minimum, 120 V rms maximum.

SEPARATION: [t₁ - t₂]: 0 second minimum

TRIGGER PULSE WIDTH: 10 nanoseconds minimum width at minimum input voltage.

REPETITION RATE: 30 MHz maximum input.

RANGE: T = +100 seconds maximum to -100 seconds minimum.

IMPEDANCE: 1 M Ω shunted by less than 20 pF (500 k Ω and 40 pF for COMMON) constant over a range of 6 V p-p times MULTIPLIER setting.

EXTERNAL ARMING: 5360A Mainframe allows external arming.

PRICE: \$750.00.

MANUFACTURING DIVISION: FREQUENCY AND TIME DIVISION
 1501 Page Mill Road
 Palo Alto, California 94304

quency and finally add the two frequencies together. The computing counter can be easily programmed with the keyboard to make both measurements, add the two together, and display the signal frequency directly (Fig. 6).

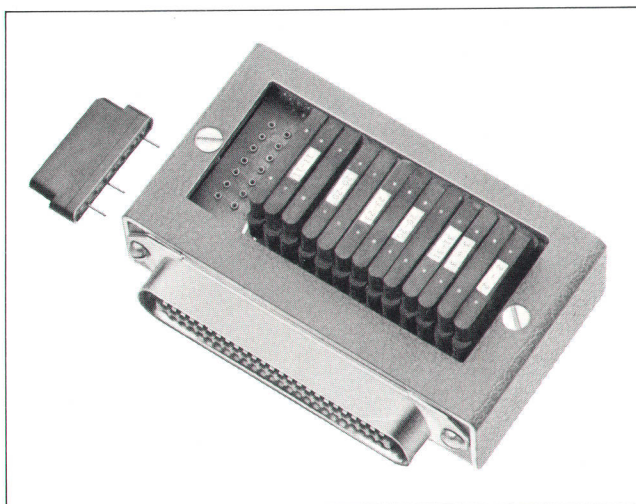

Fig. 7. Diode-matrix program assemblies can be used to program the computing counter in place of the keyboard. Diodes are packaged in groups of five, each package representing one five-bit operation code. The assembly will hold up to 16 packages, so programs can have as many as 16 steps.

Measurements of this nature are easy to make because of the flexible programming structure of the computing counter. Commands to make measurements can be mixed with computational steps, and the keyboard has complete access to this programming structure. Programming the receiver measurement is as simple as pressing eight keys; LEARN, PLUG-IN (measures LO frequency), a \leftrightarrow x (stores LO frequency), MODULE (measures IF), a \rightarrow x \rightarrow y (recalls LO frequency), ADD, DISPLAY, and RUN.

Plug-in Diode Programs

In some applications such as production testing the power of the keyboard is required but its extreme flexibility of programming is a hindrance. For these applications an interchangeable fixed-program plug is available. This unit is an oversized shell which can be plugged into the rear of the counter in place of the keyboard cable (see Fig. 7). Programming of this unit consists of simply plugging appropriate diode blocks into a matrix. Up to 16 program steps may be used. The same rear-panel connector through which this unit and the keyboard access the arithmetic unit may also be used for other special systems applications, such as interfacing the counter with a computer.

AN ELECTRONIC COUNTER FOR THE 1970'S

What does it take to build an 11-digit counter that goes to 320 MHz and makes time-interval measurements with 100-picosecond resolution?

By Gilbert A. Reeser

IF ALL ITS OTHER CAPABILITIES ARE IGNORED, and the Model 5360A Computing Counter is described only as a counter, it is a sharp departure from the past. So viewed, it is an 11-digit (maximum) counter, able to measure frequencies from dc to 320 MHz directly. It is three to a hundred times more accurate than any other counter, and even so, it is faster. Because it can begin its measurement when an input signal occurs, and because it isn't confined to fixed measuring intervals, it can measure pulsed carrier frequencies. Its resolution in measuring time interval is 100 picoseconds; by conventional methods this would require direct counting of a 10 GHz clock.

From the outset of the project it was felt that capabilities like these should be achieved to create a counter

meeting needs five years and more into the future.

Two key elements in the counter are shown in the block diagram of Fig. 1. One is the block of analog interpolators. These help make it possible to measure time intervals as brief as 100 picoseconds with a 10 MHz clock. The second is the arithmetic unit.* It works with the interpolators' data to compute time interval with greater accuracy and resolution than has ever before been possible. From this information the unit also calculates frequency, whether very low or high, faster and more accurately.

* In this article the arithmetic unit is treated as a single block. More details of its operation can be found in the article beginning on page 13.

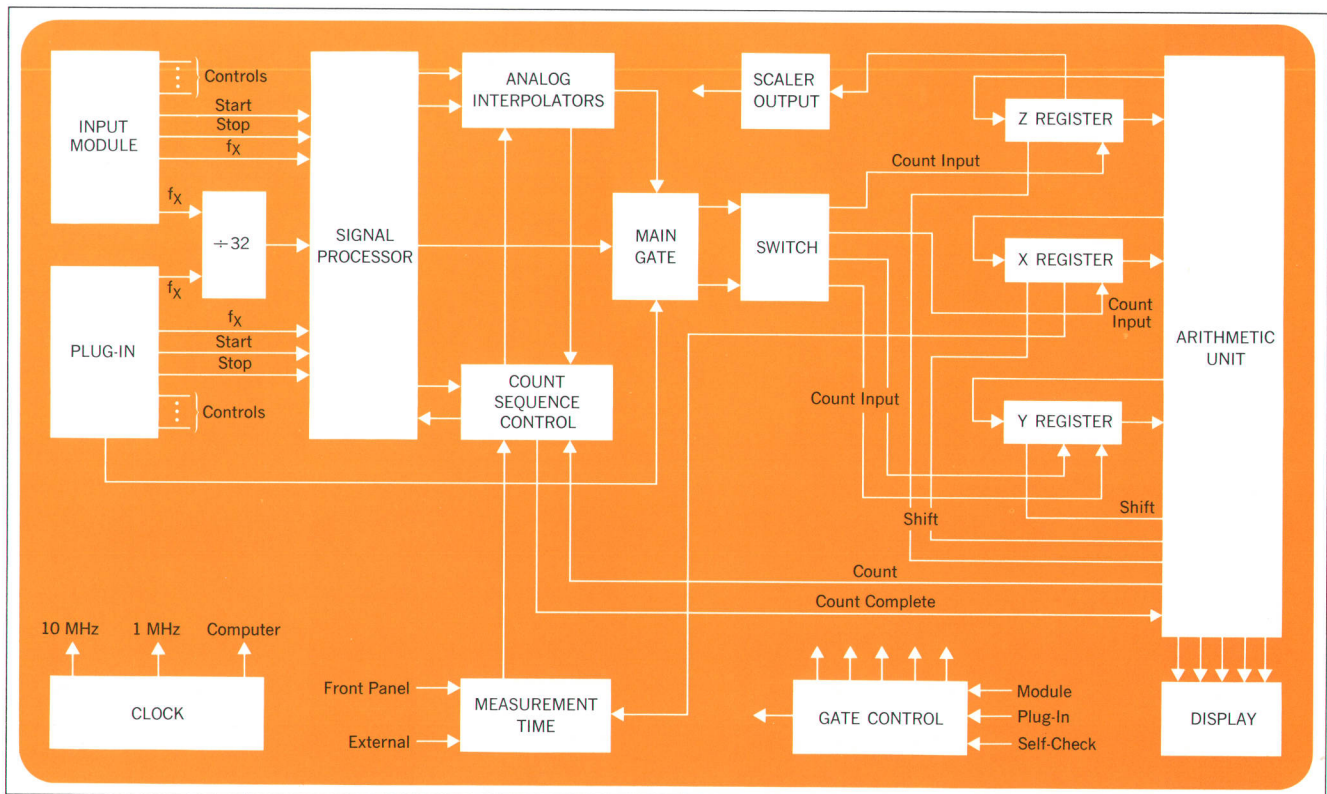

Fig. 1. Analog interpolators in the Model 5360A Computing Counter reduce the ± 1 count uncertainty by a factor of 1000. The arithmetic unit provides the computational capability needed to make use of interpolation. When the counter is counting, the X, Y, and Z registers act as decade counting assemblies.

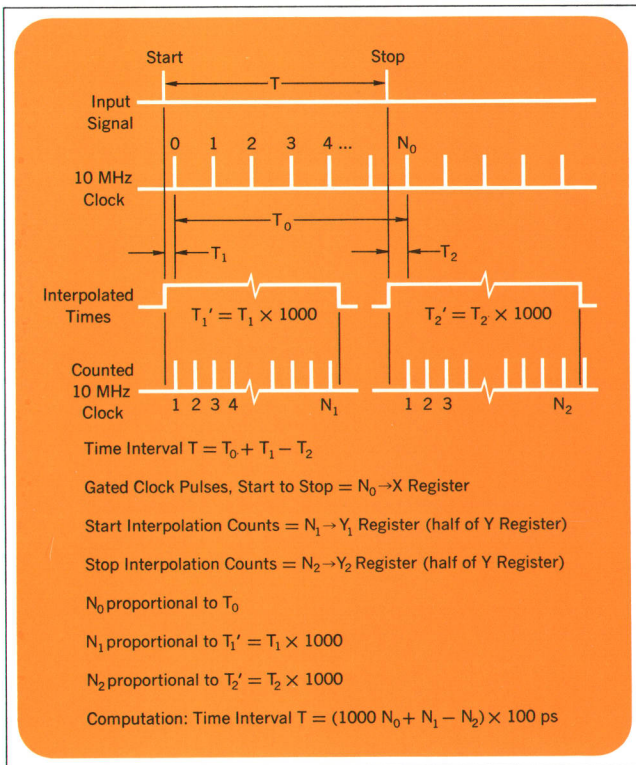

Fig. 2. Time interval is the basic measurement of the computing counter. The small times T_1 and T_2 represent the phase difference between the input start/stop signal and the internal clock. In an ordinary counter, which counts only T_0 , these times account for the ± 1 count uncertainty. In the computing counter, the analog interpolators stretch T_1 and T_2 1000 times, giving the counter a time-interval resolution of 0.1 ns although its clock rate is only 10 MHz.

Time Interval — The Basic Measurement

The computing counter begins every measurement by determining a time interval. Even if frequency is the desired quantity, the counter first measures period, and then the arithmetic unit computes frequency. But the computing counter's technique of measuring time interval is a refinement of the conventional counter's time-interval measurement.

A conventional counter measures frequency with a resolution that depends only on the measuring time and with an uncertainty of ± 1 cycle of the input signal. At very low input frequencies this uncertainty can mean very poor measurement accuracy. A frequency of 1 Hz, for example, might be indicated as 0, 1, or 2 Hz. In measuring time interval or period, the conventional counter's resolution and accuracy depend on the period of the internal clock. To measure the time interval T of Fig. 2, for example, the conventional counter would count clock pulses from the start pulse to the stop pulse. The finest unit of measurement would be one clock period, 100 ns for a 10 MHz clock frequency. There is a ± 1 count uncertainty in this measurement because the phase relationship between the start/stop signal and the internal clock isn't known. However, the ± 1 count uncertainty is ± 1

clock period, not ± 1 period of the input signal. Therefore, a counter that measures period in the conventional way and then inverts it to get frequency is much more accurate at low frequencies than a direct-frequency-counting instrument.*

The computing counter gets frequency by inverting period, but it measures period and time interval in an unconventional way. Although its internal clock frequency is 10 MHz, its time-interval resolution is 0.1 ns, the period of a 10 GHz clock.

To measure the time interval T of Fig. 2, the computing counter actually makes three separate measurements:

- The time interval T_0 between the first time-base or 'clock' pulse after the start pulse and the first clock pulse after the stop pulse.
- The time interval T_1 between the start pulse and the first clock pulse.
- The time interval T_2 between the stop pulse and the next clock pulse.

The time T_0 is measured by simply accumulating the N_0 clock pulses that occur during that interval. T_1 and T_2 first are multiplied 1000 times by the interpolators and then are measured in the conventional way. This reduces the significance of the ± 1 count uncertainty by a factor of 1000.

* The Model 5323A Automatic Counter does this. See article, page 17.

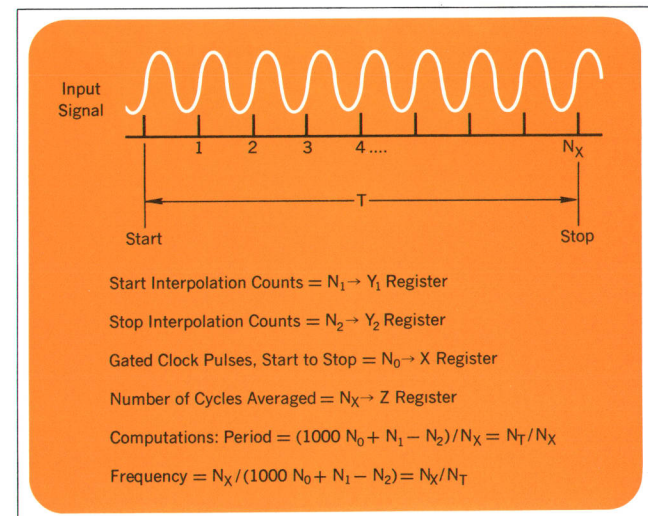

Fig. 3. For period and frequency measurements the computing counter's measurement cycle is synchronized with the input signal. The selected measurement time is actually a minimum value; the actual time is an integral number of input periods. Besides measuring T_0 , T_1 , and T_2 as for time interval, the counter counts the input periods N_X and then computes period or frequency.

The 'start' interpolator measures T_1 . During the time T_1 a constant current charges a capacitor. This capacitor is then discharged at a rate 1000 times smaller, so the time taken to discharge the capacitor to its initial state is 1000 times longer than the charging time T_1 . The stretched time T_1' is then measured by counting the number of clock pulses N_1 occurring over the interval T_1' . In a similar manner, the 'stop' interpolator stretches the real time T_2 1000 times so it can be measured by counting the number of clock pulses N_2 occurring over the stretched time interval T_2' . The unknown time interval T is

$$T = T_0 + T_1 - T_2,$$

and the counts N_0 , N_1 , and N_2 contain all the information needed to compute it.

The counts N_0 , N_1 , and N_2 are accumulated and stored in shift-count registers X and Y, which are two of the three principal registers in the machine. The clock frequency counted is always 10 MHz, so each count stored represents a time of $1/(10 \text{ MHz}) = 100 \text{ ns}$. Therefore the time interval T is

$$T = \left(N_0 + \frac{N_1}{1000} - \frac{N_2}{1000} \right) \times 100 \text{ ns}$$

or $T = N_T \times 100 \text{ ps}$,

where $N_T = 1000 N_0 + N_1 - N_2$.

Following the count cycle, then, a number of arithmetic operations are performed on the registers' contents. The result is that the X register contains the quantity N_T which represents the magnitude of the time interval T in units of 100 picoseconds.

Period and Frequency Measurements

Period measurements are similar to time-interval measurements. To make period-average measurements, the user sets the front-panel MEASUREMENT TIME controls so the measurement time spans the desired number of periods of the input signal. The end of the period-average measurement occurs with the first input trigger after the selected MEASUREMENT TIME expires. For example, measuring a period of 300 ms with the MEASUREMENT TIME set at one second results in four periods being measured, a total of 1.2 s. If the MEASUREMENT TIME were set at 300 ms or less, only one period would be measured.

To measure period, the counter again measures time interval, but in this case the measurement time is N_x periods of the input (see Fig. 3). The number N_x is accumulated and stored in the Z register, the third principal

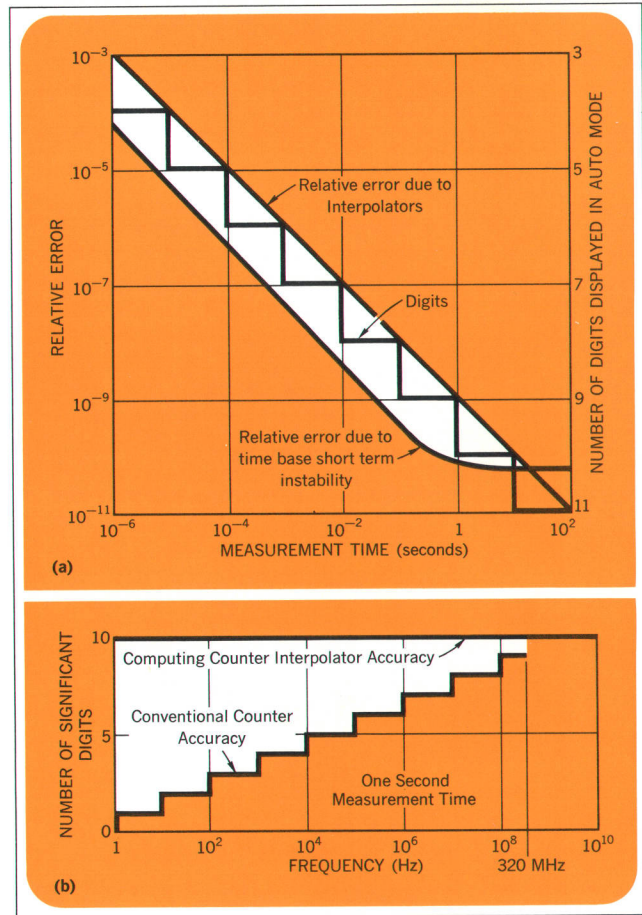

Fig. 4(a). Computing counter interpolator and time-base accuracy. (b) Computing counter interpolator accuracy compared with ± 1 count uncertainty of conventional frequency counter for one-second measurement time.

register in the computing counter. The unknown period is given by

$$\text{Period} = \frac{1000 N_0 + N_1 - N_2}{N_x} = \frac{N_T}{N_x}.$$

Hence the arithmetic operations which follow the count cycle are slightly different from the time-interval case.

Frequency measurements are the same as period measurements except that the arithmetic unit computes N_x/N_T , the inverse of the period.

Interpolator and Time-Base Accuracy

The computing counter's accuracy depends primarily on the accuracy of the interpolators which measure T_1 and T_2 and on the stability of the time base. Fig. 4(a) shows the magnitudes of interpolator errors and time-base instability for various measurement times. Also shown is the number of digits the counter will display when the DIGITS DISPLAYED switch is set to AUTO. Fig. 4(b) compares the computing counter's interpolator accuracy with the ± 1 count uncertainty of a conventional direct-frequency-counting instrument, both for a one-second measurement time.

Stability of the time base in the computing counter



Gilbert A. Reeser

Gil Reeser came to HP in 1964 after three years as a research engineer in high-energy physics and two years as a project leader in radar-system design. He helped redesign the 5245L Counter and worked on RFI in counters, then became a group leader and one of the principal designers of the 5360A Computing Counter. Now that the instrument is in production, Gil is staying with it as product manager, responsible for marketing.

Gil received his BSEE degree in 1959 from Colorado State University and his MSEE in 1965 from Stanford. He is a member of IEEE.

equals or surpasses that of many house frequency standards. Its aging rate is less than 5 parts in 10^{10} per 24 hours, and its short-term stability, which is important for reading-to-reading agreement in such a high-resolution instrument, is better than 5 parts in 10^{11} for a one-second averaging time. If still greater stability is needed, an external atomic frequency standard can be used.

The interpolators are enclosed in a constant-temperature oven to preserve their accuracy, and once they have been calibrated they will remain calibrated for several weeks. Calibration takes only a few seconds. A CALIBRATE switch is accessible from the front panel through

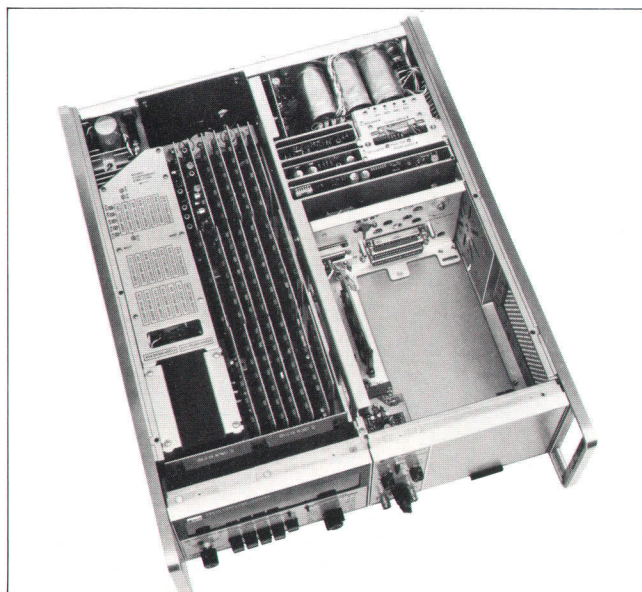

Fig. 5. Where to put 500 IC's, a 5 V, 10 A power supply, the crystal and interpolator ovens, and the other circuits was a problem that took six man-years to solve. All parts are easily removable for servicing.

the plug-in compartment. Placing it in the CALIBRATE position sends two pulses exactly 100 ns apart into the counting circuits. If the split display does not read 1000 (100 ns is 1000×100 ps), variable resistors at the rear of the plug-in compartment are adjusted until the split display does read 1000. This calibrates both interpolators.

Product Design

Driving the 500 IC's in the computing counter and providing ample power for plug-ins and accessories requires a 5 V, 10 A power supply. But low-voltage high-current supplies which have conventional regulators are very inefficient because of the voltage drop across the regulating transistors. A conventional supply for the counter would have been as big as the entire instrument is now. The space saver that makes it possible to get the entire instrument into its relatively small cabinet is a switching mode regulator, which allows the power to be generated at a higher voltage and therefore more efficiently. An aluminum casting shields the regulator and acts as a heat sink.

The power dissipation and the placement of the crystal and interpolator ovens were serious constraints on the mechanical design. The final design is a significant achievement (Fig. 5). The circuit boards, the readout, and the ovens are all easily removable for servicing.

The high-speed counting circuits are also housed in an aluminum casting to ensure good shielding and keep the fast-risetime pulses from radiating into other parts of the instrument. A computer-controlled wiring machine is used to make the more than 1000 interconnections between pins on the integrated-circuit boards.

Acknowledgments

The Computing Counter is the result of the cooperation and enthusiastic efforts of many individuals working under section leader Charles Hill. David Smith headed the product design and Lawrence Brendlen was responsible for the overall mechanical design. Work on the interpolation scheme and overall product definition was initiated by Merrill Brooksby. Jeffery Wolfington, William Olsen, and Keith Ferguson worked on the high-speed counting, signal-processing, and interpolation circuitry. John Gliever was responsible for the input module and the time-interval plug-in. Alfred Thorne, Robert O'Keefe, and William Anson contributed throughout. The counter reflects the high quality of the work both of these individuals and of those who worked on the arithmetic unit, which is described in the article that follows. 

circuit. The arithmetic unit of the computing counter uses more than 400 digital IC packages which contain more than 1000 gates and flip-flops made up of more than 10,000 transistors.

The Arithmetic Unit

By itself, the arithmetic unit can be thought of as a desk calculator without a keyboard. In place of a keyboard, it is told what mathematical operations to perform by short programs wired into the counter mainframe, the input module, the plug-in, or external units such as read-only diode matrices plugged into the rear panel of the counter. It can also be controlled by the accessory keyboard, in which case it is similar to a programmable desk calculator.

The arithmetic unit (see Fig. 1) has two functional sections, the *programming circuits* and the *arithmetic processor*. The programming circuits generate five-bit binary operation codes which tell the processor what operations

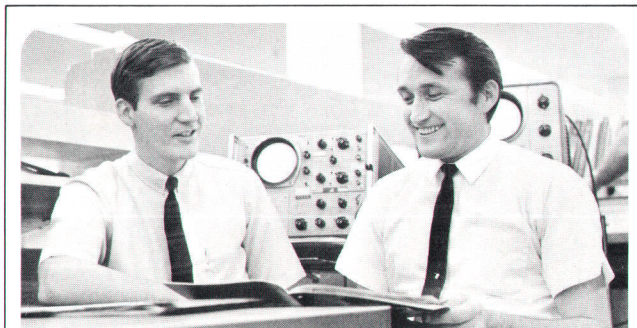

France Rodé (right) led the group that developed the arithmetic unit of the 5360A Computing Counter. He joined HP in 1962 and designed counter circuits for two years before starting on the computing counter.

France holds the degree Diploma Engineer from Ljubljana University in Yugoslavia. He also taught there for six months as an assistant professor before coming to the United States. In 1962 he received the MSEE degree from Northwestern University. When he isn't designing digital equipment, he likes to ski, play chess, and draw and paint.

France recently left HP to join a small newly formed digital company in the northeastern U.S.

Gary Gordon (left) joined HP in 1966 and worked with France Rodé in developing the arithmetic unit of the 5360A Computing Counter. He received his BSEE degree from the University of California at Berkeley in 1962 and is about three-quarters of the way towards his MSEE at Stanford University on HP's Honors Cooperative Program. Gary also developed the 10525A Logic Probe. He has several patents pending in the field of digital design, and he is now a project engineer in the Frequency and Time Division Laboratory.

A former U.S. Navy Lieutenant, Gary has traveled extensively in the Orient. Among his interests he lists banjo playing, furniture building, sailing, and astronomy.

to carry out. The numbers on which the operations are performed are contained in three shift-count registers in the processor section; they are labeled X, Y, and Z. The table on page 15 lists the thirty-two (2^5) possible operation codes and shows what they do to the contents of the X, Y, and Z registers. Answers are always placed in the X register and are transferred to the display register on command.

The arithmetic unit was designed to have a large repertoire of thirty-two operations so individual programs could be short. Five to ten steps is the usual length.

Shift-Count Registers

When the counter is counting, the X, Y, and Z registers act as 10 MHz decade counting assemblies. When the count is complete the results are stored in these registers. Then when a program calls for a mathematical operation these registers switch roles and become shift registers, circulating their data through the processing circuits at a shift rate of 1 MHz.

Processing is done serially, one digit at a time. This results in a saving in circuitry over parallel operation. The speed is a little slower, but the serial operation is still fast compared to most measurement times. The counter can make more than 300 frequency or period measurements per second.

The X, Y, and Z registers hold their data in floating-point form. A fixed-point number such as 453.786 is represented in floating-point notation as 4.53786×10^2 . It has a mantissa, 4.53786, and an exponent, 2. For internal handling, numbers are split into their four parts: the mantissa and its sign and the exponent and its sign. All storage is in binary flip-flops, but the coding varies; it is 12-digit binary-coded-decimal for mantissas and 5-bit binary for exponents. Thus the storage range is $10^{\pm 32}$. The display range, on the other hand, is $10^{\pm 15}$ (femto to tera). Although the display range is wide enough for virtually all measurement operations, the internal storage range was purposely made larger so the operations of squaring and square-rooting could be done without overflowing the registers.

In addition to the shift-count registers, the counter can have up to four storage registers. When a storage operation is called for, the arithmetic processor takes the number in the X register and shifts it into the storage register addressed by the operation code.

Programming Circuits

The programming circuits consist of the *program selector* and the *programs* themselves. Programs in the

Fig. 2. Internal programs in the computing counter are all read-only diode matrices or combinatorial gating networks. External programs can come from a diode matrix, the keyboard, a computer, or some other special device. This four-step diode-matrix program multiplies the measured frequency by a harmonic number; it might be used in a transfer-oscillator plug-in.

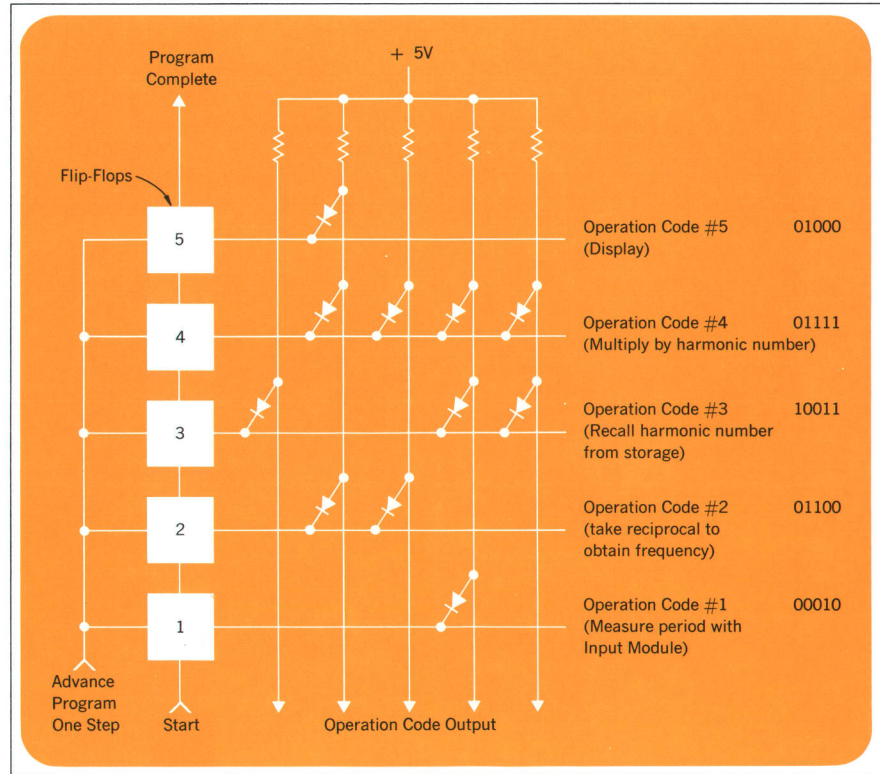

computing counter are all of the hard-wired read-only type, some made up of diode matrices (see Fig. 2) and others made up of gating networks. In addition to

these internal programs, programs may be entered manually and stored in the accessory keyboard, or single steps may be executed manually using the keyboard.

There are three levels of programs. At the top level a keyboard or external program has the greatest control over the measurement functions and computations. If this option is not used, then the front-panel pushbuttons pass control down to the second level, the module, plug-in, or self check subprograms. These subprograms in turn have access to the computational steps and to the lowest level of programs, the four subroutines, which are $N_T = (1000 N_0 + N_1 - N_2)$, square root, X/Z , and $\div 32$. These subroutines will be shared by many of the plug-ins and so are located in the mainframe; thus their cost won't be added to each new plug-in that needs them. The square-root subroutine is useful in rms calculations and it can be called by an external program. The subroutines have access to the arithmetic processor.

Only one operation code at a time from any program can be gated onto the five lines which go to the arithmetic processor. The *program selector* decides which program will be in control at each step.

The programming circuits also control the timing of programs, which is serial and asynchronous. Programs are not advanced or interchanged until arithmetic-step-complete pulses or sub-program-complete pulses are generated by the appropriate circuits. Count commands and display commands are treated as arithmetic steps, so programs do not advance until count-complete and display-holdoff-complete pulses are received.

The Arithmetic Processor

After the programming circuits have read the operation-code requests from the various programs in the

Arithmetic Operations Accessible by External Programs

Code 16 8 4 2 1	Name	Description	Register Contents After Operation*		
			X	Y	Z
0 0 0 0 0					
0 0 0 0 1					
0 0 0 1 0	MODULE	Call Module Subprogram			
0 0 0 1 1	PLUG-IN	Call Plug-in Subprogram			
0 0 1 0 0					
0 0 1 0 1	\sqrt{X}	Square-Root Subroutine	\sqrt{a}		
0 0 1 1 0	CHECK	Call Check Subprogram			
0 0 1 1 1	CAL	Call Calibrate Subprogram			
0 1 0 0 0	DISPLAY X	Display contents of X register	a	b	c
0 1 0 0 1	10 X	Multiply X by 10	10a	b	c
0 1 0 1 0	ADD	Add X to Y	a + b	a	c
0 1 0 1 1	SUBTRACT	Subtract X from Y	b - a	a	c
0 1 1 0 0	1/X	Reciprocal of X	1/a	a	c
0 1 1 0 1	LOAD	Enter New Number	a'	a	c
0 1 1 1 0	DIVIDE	Divide Y by X	b/a	a	c
0 1 1 1 1	MULTIPLY	Multiply Y by X	ab	a	b
1 0 0 0 0					
1 0 0 0 1	X \leftrightarrow A	Interchange X and A**	S _x	b	c
1 0 0 1 0					
1 0 0 1 1	A \rightarrow X \rightarrow Y	Copy A into X and X into Y	S _x	a	c
1 0 1 0 0	2 X	Add X to X	2a	b	c
1 0 1 0 1	X \leftrightarrow Y	Interchange X and Y	b	a	c
1 0 1 1 0	CLEAR X	Reset X to Zero	0	b	c
1 0 1 1 1	X \rightarrow Y	Copy X into Y	a	a	c
1 1 0 0 0					
1 1 0 0 1	X \leftrightarrow B	Interchange X and B**	S _b	b	c
1 1 0 1 0					
1 1 0 1 1	B \rightarrow X \rightarrow Y	Copy B into X and X into Y	S _b	a	c
1 1 1 0 0	X/10	Divide X by 10	a/10	b	c
1 1 1 0 1	X \leftrightarrow Z	Interchange X and Z	c	b	a
1 1 1 1 0	CLEAR X Y Z	Reset X, Y, and Z to Zero	0	0	0
1 1 1 1 1	Z \rightarrow X \rightarrow Y	Copy Z into X and X into Y	c	a	c

*Contents before operations: X = a, Y = b, Z = c

**A is a storage register in the mainframe. Contents: S_A
B is a storage register that can be provided in an external device. Contents: S_B

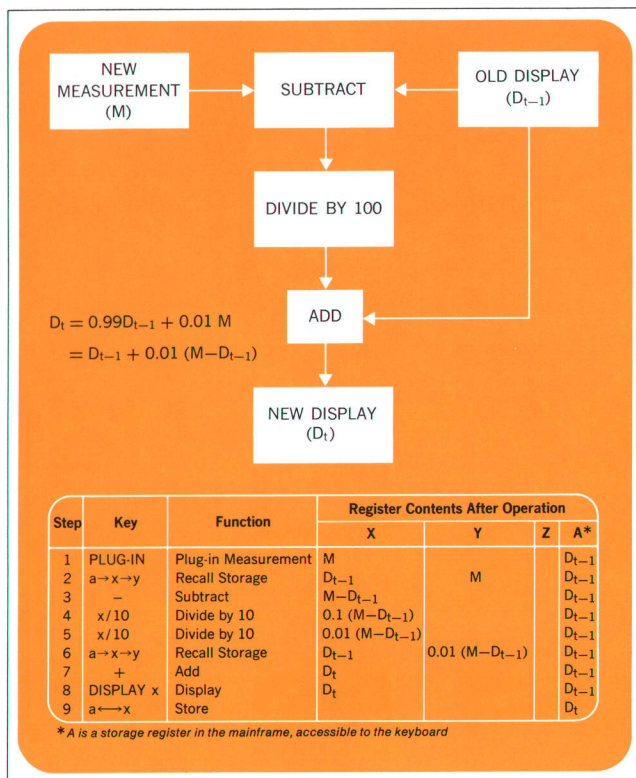

Fig. 3. This algorithm causes the computing counter to display a weighted running average of its measurements. The table shows the steps in the program and what they do to the register contents.

counter and have woven them together into a single set of five binary signal lines, it is up to the arithmetic processor to read the operation code on these lines and perform the corresponding sequence of operations on the contents of the X, Y, and Z registers. In the processor are many data routes by which register contents can be interchanged or passed through the adder. The arithmetic operations—add, subtract, multiply, and divide—are accomplished by repetitive shifts and passes through the adder. An exponent manipulation is associated with each operation; for example, during multiplication the exponents are added. All of the shifting, gating, and adding needed to execute the operation code is done under the control of the *arithmetic control*.

Inputs to the arithmetic control are the five-bit operation codes. The outputs of the arithmetic control are over 100 lines which open and close gates between registers and perform other timing and control functions. The arithmetic control has the formidable job of simultaneously applying the correct sequences of commands to these 100 lines so the processor will execute the operation called for. These sequences vary in length from about 15 steps to interchange the contents of two registers to

about 1000 steps to divide one number by another. The clock rate is 1 MHz, so the steps are one microsecond apart.

External Programming and an Example

When the front-panel EXT button is pressed, control of the arithmetic unit is assumed by any programming device connected to the rear-panel EXTERNAL CONTROL connector. Programs can be generated by a keyboard or by a plug-in diode matrix like that shown in Fig. 7, page 8. The operation codes that can be used in external programs are listed in the table, page 14.

As an example of an external program, suppose we want to average several time-interval measurements to reduce the effects of noise on the input signal. One method would be to accumulate 10, 100, or more measurements, divide the sum by the appropriate power of 10, and display the quotient. With this simple averaging scheme, however, the user may have to wait some time between displays. An easier yet more elegant solution is to compute and display the weighted running average. This average gives a new updated display for each measurement cycle, yet each display is a weighted average of all previous measurements. This kind of averaging is accomplished by converging the old display a certain amount, say 1%, toward the most recent measurement. Mathematically, this operation corresponds to convolving the measurements with a decaying exponential. The algorithm and the keys that program it are shown in Fig. 3. Also shown are the effects of each program step on the contents of the shift-count and storage registers.

Another example of the use of the keyboard is in the article beginning on page 2.

Acknowledgments

The arithmetic unit reflects the influence of numerous engineers in the lab, whose many contributions we gratefully acknowledge. Particularly valuable were comments from our section manager, Charles Hill, on the organization and control of the arithmetic unit. The design team itself included Richard Ollins, who designed portions of the arithmetic processor and the input module; Roger Smith, who took over responsibility for the programming circuitry and the fixed program plug; and Richard Buchanan, who worked on the early keyboards. The design of the special IC's was supervised by Ian Band. Keith Ferguson is now project leader on the 10537A Keyboard, with Lawrence Brendlen and Keith Leslie handling its mechanical design.

Automatic Counter Inverts Period to Get Frequency

The computing counter's little brother measures frequencies between 0.125 Hz and 20 MHz with seven-digit resolution and fully automatic ranging. It also measures pulsed carrier frequencies directly.

By Ian T. Band

LOW-COST COMPLEX INTEGRATED CIRCUITS have made it feasible to include computers in electronic counters to simplify the instruments' controls and improve their performance. A case in point is the new HP Model 5323A Automatic Counter, which uses computing integrated circuits to gain the benefits of completely automatic ranging over a very wide dynamic frequency range, several orders of magnitude improvement in measurement resolution at low frequencies, and many new display features which help to eliminate possible errors in the interpretation of the displayed frequency. Most of the function controls found on other counters are gone; in their place is a single control which selects the one parameter the machine can't select by itself — how many readings to display per second (see Fig. 1).

Mini-Computing Counter

The Model 5323A Automatic Counter was a logical step in the evolution of the more sophisticated Model 5360A Computing Counter. In concept these two instru-

ments are the same, although the Model 5323A does not have the powerful interpolation techniques or vast measurement capabilities of its big brother.

A precise time-interval measurement over an arbitrary number of cycles of the input signal is the basis of the automatic counter's frequency measurements. The beginning and end of the chosen time interval are synchronized with the incoming signal, so the only limitation on



Fig. 1. Model 5323A Automatic Counter measures frequencies by measuring and inverting the period of the input signal. It's completely automatic — the only function control is for selecting the measurement time, which can have non-decade or even (using an external gate) unknown values. Resolution is 7 digits maximum for any frequency, 0.125 Hz to 20 MHz.

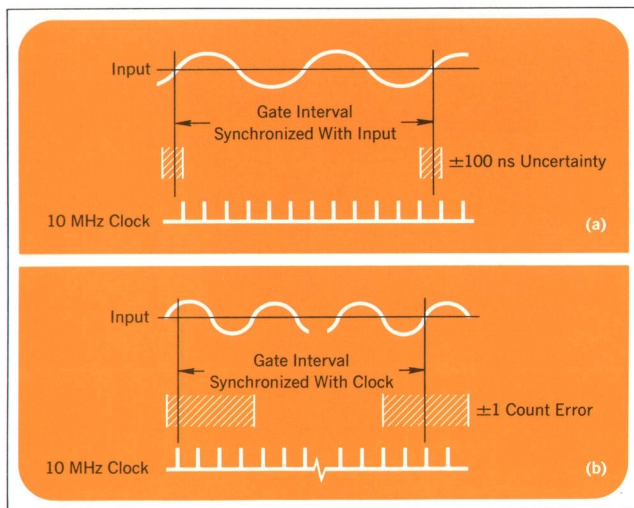

Fig. 2. By measuring period instead of frequency the automatic counter gets much better resolution at low frequencies than a direct-counting instrument with the same 10 MHz clock rate. (a) Time-interval (period) measurement of N input cycles. Resolution is a constant 100 ns for any input frequency. (b) Direct frequency count. Resolution is ± 1 count of the input frequency.

the measurement resolution is the ± 100 ns uncertainty in the timing of the counter's unsynchronized 10 MHz crystal time-base frequency. This is illustrated in Fig. 2(a). Thus the resolution is independent of the input frequency and is equivalent in all cases to a direct-counting measurement of a 10 MHz input frequency. Any frequency between 0.125 Hz and 20 MHz can be measured and displayed with 7-digit resolution. By comparison, the resolution of the direct-frequency-counting method is limited to ± 1 count of the input signal. This is very poor at low frequencies, as illustrated in Fig. 2(b). A frequency of 1 Hz, for example, measured during a one-second gate would be accurate within $\pm 100\%$. The counter's reading could be only 0, 1, or 2 depending upon the timing accuracy and phasing of the gate.

How the Automatic Counter Works

The automatic counter's basic time-interval measurement is made by counting precise 10 MHz clock pulses in a decimal counting register (register Y in the block diagram of Fig. 3) during the gate interval. A synchronizing circuit ensures that the opening and closing of the gate are synchronized with the input signal. During this same gate interval, the number of input cycles which have occurred are also counted and accumulated in decimal register X. The number contained in each of the registers at the end of the gate interval is the product of the time

interval T and the register input frequency, that is,

$$X = T \cdot f_x \text{ and } Y = T \cdot f_y.$$

The unknown signal frequency f_x is then calculated by dividing X by Y to yield f_x/f_y . The factor $f_y = 10^7$ is eliminated by a decimal-point shift in the answer.

In the automatic counter the quotient X/Y is calculated by conventional computing techniques. It takes only about 1 ms to compute and display the result. Division is done by repeated subtractions and testing for a positive or negative remainder. The data are handled throughout in binary-coded-decimal form. During the computing portion of the measurement cycle the X and Y registers change roles and act as shift registers to circulate the data through the computing circuits.

Each of the registers contains eight counting and shifting integrated decades and has a capacity of 10^8 counts. The large register capacity allows the automatic counter to make measurements for as long as 8 seconds without having to divide the 10 MHz clock frequency. At high input frequencies a four-second limit is automatically set so frequencies as high as 25 MHz can be measured without overflowing the X register.

Measurement Time Control

All range switching in the Model 5323A is automatic. The displayed frequency is positioned at the left of the readout and all significant digits are shown. The computer determines the correct position for the decimal point and the correct units of Hz, kHz, or MHz. The counter cannot, however, decide how many readings to display per second, since this usually depends on the application or on what is the most comfortable rate for the observer. If an immediate response to changes in input frequency is required, a short measurement time would be used. Longer measurement times would be used for increased resolution and noise averaging.

The new counter's measurement time and number of readings per second are controlled by the front-panel MEASUREMENT TIME control, which replaces the sample-rate and gate-time controls found on older counters. Measurement times are not limited to decade values. Those selectable on the front panel are 0.01, 0.04, 0.1, 0.2, 0.4, 1, 2, and 4 seconds. Variable measurement times up to four seconds can be obtained by applying an external gate signal to a rear-panel input.

The selected measurement time is actually a minimum value. The measured time interval must be exactly synchronized with the input signal, so after the selected measurement time expires the counter automatically waits

until an appropriate input trigger occurs and then terminates the measurement. For example, with a selected measurement time of one second and an input frequency of 123.4567 Hz the counter will measure the time interval for 124 cycles of the input which would take 1.004595 seconds. After an additional 1 millisecond of computing time the frequency would be displayed as 123.4567 Hz. The measurement cycle is shown in Fig. 4.

Automatic Reset Prevents Errors

Since the counter must wait for an input signal to trigger the end of the measurement, it could wait indefinitely if the signal disappeared during the measurement. Overflow of the registers would signal that something was wrong, but this would not give a fast indication that the signal had disappeared until it was too late. This would be critical in automatic control situations. To prevent this, the counter will only wait as long as twice the minimum measurement time and if no signal has occurred the counter will automatically reset to zero, re-arm, and wait for a new signal. The minimum frequency which can be measured is that frequency which would have completed only one cycle within the maximum time, or whose period is twice the selected measurement time.

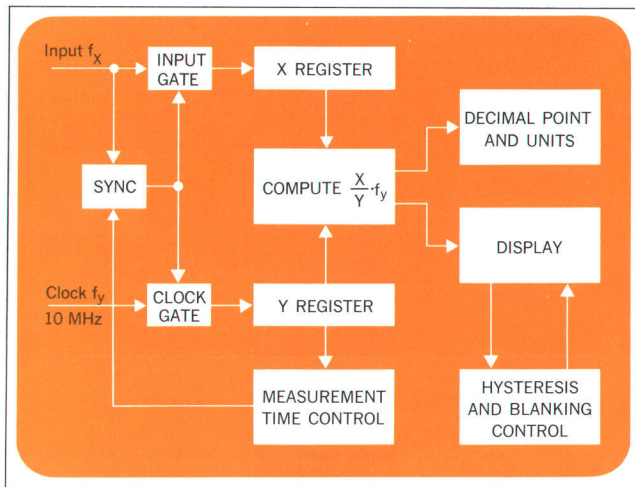

Fig. 3. Computing integrated circuits divide the number of input cycles (X) by the number of clock periods (Y) and multiply by $f_y = 10^7$ to find the unknown frequency f_x . Other IC's determine the measurement units, position the decimal point, blank insignificant digits, and apply hysteresis to prevent display jitter.

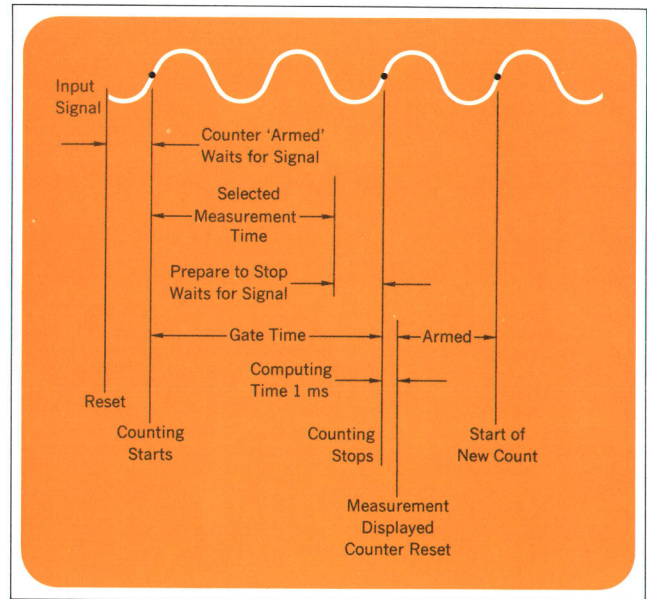

Fig. 4. The automatic counter's measurement cycle is always synchronized with the input signal. The selected measurement time is actually a minimum value.

Insignificant Digits Suppressed

The automatic counter has many of the advanced display features found in the more powerful computing counter. One of these is blanking of insignificant digits to the right of the display. For example, with a measurement time of 0.1 second, the counter's 100 ns resolution would be one part in 10^6 and the counter could accurately display a frequency of 100 Hz as 100.0000 Hz. However, in the same measurement time a reading of 99.9999 Hz is only accurate to 6 digits. The counter doesn't display the insignificant 7th digit in this case, but blanks it unless overridden by the rear-panel blanking switch. Blanking allows the user to select his best measurement time without worrying about the significance of the answer, which will always have the maximum number of usable digits.

Hysteresis Prevents Display Jitter

Another possible case of readout confusion could occur when the input frequency has enough jitter to cause the display to alternate between two ranges. In an extreme case, such as $1 \text{ MHz} \pm 1 \text{ Hz}$, the decimal point, the displayed units, and the displayed frequency would all be changing together. To prevent this, the automatic counter has a hysteresis control which can be switched in from the rear panel to keep the range from changing twice unless the input frequency has shifted by more than 10%. An increasing frequency which would cause the range to change at 100 Hz, for example, would not change back to the previous range as the frequency drops again unless the frequency goes below 90 Hz.

BRIEF SPECIFICATIONS

HP Model 5323A Automatic Counter

RANGE: dc coupled: 0.125 Hz–20 MHz.
ac coupled: 10 Hz–20 MHz.

MEASUREMENT TIME: Selectable; 0.01, 0.04, 0.1, 0.2, 0.4, 1.0, 2.0, 4.0 s, or any time up to 4 s determined by the duration of an external gate signal.

COMPUTING TIME: Approximately 1 ms.

ACCURACY: ± 1 count \pm time base error \pm noise.

RANGE SELECTION: Automatic.

HYSTERESIS: Range switching will automatically position the most significant digit in the first display position, except when the frequency is decreasing from 10xxx to 09xxx. In this case range switching is delayed until the input drops below 09xxx. This 10% hysteresis prevents unnecessary range changes due to input frequency jitter. Hysteresis may be inhibited by a rear panel switch.

SIGNAL INPUT:

Sensitivity (min): 0.1 V rms sine wave.
0.3 V p-p pulso, 25 ns minimum pulse width.

Sensitivity can be decreased by 10 or 100 times using the ATTENUATOR switch.

Impedance: 1 M Ω shunted by 35 pF.

Trigger Level: PRESET to center triggering about 0 V, or adjustable.

Trigger Threshold Band: <1.0 mV, referred to input at 20 MHz.

TIME BASE:

CRYSTAL FREQUENCY: 10 MHz.

CRYSTAL OVEN: Self-regulating solid-state type.

STABILITY:

Aging Rate: Less than 3 parts in 10⁷/mo.

Temperature: $\leq \pm 7$ parts in 10⁷/°C.

Line Voltage: $\leq \pm 1$ part in 10⁷ for $\pm 10\%$ line voltage variation.

OSCILLATOR OUTPUT: 10 MHz, 1.0 V p-p, 50 Ω (approx) source impedance at rear panel BNC.

EXTERNAL INPUT: 1.0 V rms at a frequency of 1, 2.5, 5, or 10 MHz.

GENERAL:

DISPLAY: 7-digit in-line digital readout plus positioned decimal point, units annunciator, and rpm annunciator.

BLANKING: All non-significant digits will be automatically blanked if the measurement time selected on the front panel

is too short to guarantee full accuracy. Rear panel switch allows all digits to be displayed without blanking if desired.

RPM DISPLAY: Rear panel switch connects an internal X60 multiplier that converts measurement from pulses per second to revolutions per minute.

GATE OUTPUT: 0 V while counting, +4 V otherwise. Available at rear panel BNC.

AUTOMATIC RESET: The counter will automatically reset to zero if the input is removed during any measurement, or if the period of the input signal is longer than twice the selected measurement time.

REMOTE PROGRAMMING: All front panel function controls are programmable. Single line control for each function. Operated by DTL or TTL integrated circuits or contact closure to ground.

DIGITAL OUTPUT:

Code: All numerals, decimal point, and unit information are available as 4-line 8-4-2-1 coded signals.

Storage: Buffer storage is provided so BCD output is held constant while next measurement is being made.

OPERATING TEMPERATURE: 0° to 50°C.

PRICE: \$2150.00.

MANUFACTURING DIVISION: FREQUENCY & TIME DIVISION
1501 Page Mill Road
Palo Alto, California 94304

Measuring Pulsed Carrier Frequencies

The automatic counter has the ability to measure carrier frequencies which are only present in short bursts. Since the counter won't begin a measurement until a signal appears, it isn't necessary to know the exact time when the burst will be present. A reset signal which occurs any time before the burst will arm the counter, and the first cycle of the burst will begin the measurement. The measurement time should be short enough so the measurement will be completed before the burst ends, yet long enough so as many cycles of the signal as possible will be measured, for maximum accuracy. Here the auto-

matic counter's wide selection of measurement times is valuable, because it makes it possible to select a measurement time close to the optimum. The HOLD mode of the counter must be used for this type of measurement, to prevent the counter from recycling immediately. Special circuitry causes the reset signal to suppress the HOLD command until the completion of one full measurement and display cycle.

Maximum accuracy would be obtained by measuring from the first cycle to the last cycle of the burst. The complete burst, or any segment of it, can be precisely selected and measured by using the EXTERNAL GATE input at the rear of the instrument. The external gate does not open and close the gate circuits directly, as it would in a conventional counter, but enables the start and the stop of the measurement which are still exactly synchronized with the input signal.

Other Features

A rear-panel switch causes the automatic counter to multiply its count by 60 and display the input frequency as revolutions per minute instead of hertz. There are also rear-panel inputs for remote programming. All front-panel function controls are programmable.

Acknowledgments

I am grateful to Glen Elsea for the product design of the Model 5323A Automatic Counter, and to Roger Lee and Paul Rasmussen for the industrial design, especially the attractive front panel.



Ian T. Band

Ian Band came to HP in 1965 to take charge of the integrated-circuit design section of the Frequency and Time Division. He designed the first HP integrated circuits, as well as many of the special IC's for the 5360A Computing Counter and the 5323A Automatic Counter. Now an engineering group leader, Ian was the principal designer of the 5323A.

Ian received his BS and MS degrees in physics from St.

Andrews University, Scotland, in 1957 and 1958. He is a member of IEEE. For relaxation he sails his Rhodes 19, or goes flying or skiing, presumably depending on the weather.

HEWLETT-PACKARD JOURNAL MAY 1969 Volume 20 • Number 9

TECHNICAL INFORMATION FROM THE LABORATORIES OF THE HEWLETT-PACKARD COMPANY PUBLISHED AT 1501 PAGE MILL ROAD, PALO ALTO, CALIFORNIA 94304
Editorial Staff: F. J. BURKHARD, R. P. DOLAN, L. D. SHERGALIS, R. H. SNYDER Art Director: R. A. ERICKSON